



ELECTRIC FORKLIFT
SIT-ON REACH TRUCKS
FBRF 14/16/20



The Leader in Reach Truck Innovation

The FBRF Series

Excellent standard features

Reach trucks must meet three basic criteria: fast travel, high lift capability and compact design. The new FBRF series clearly excels at all three.

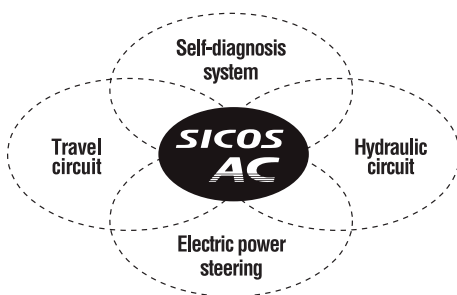
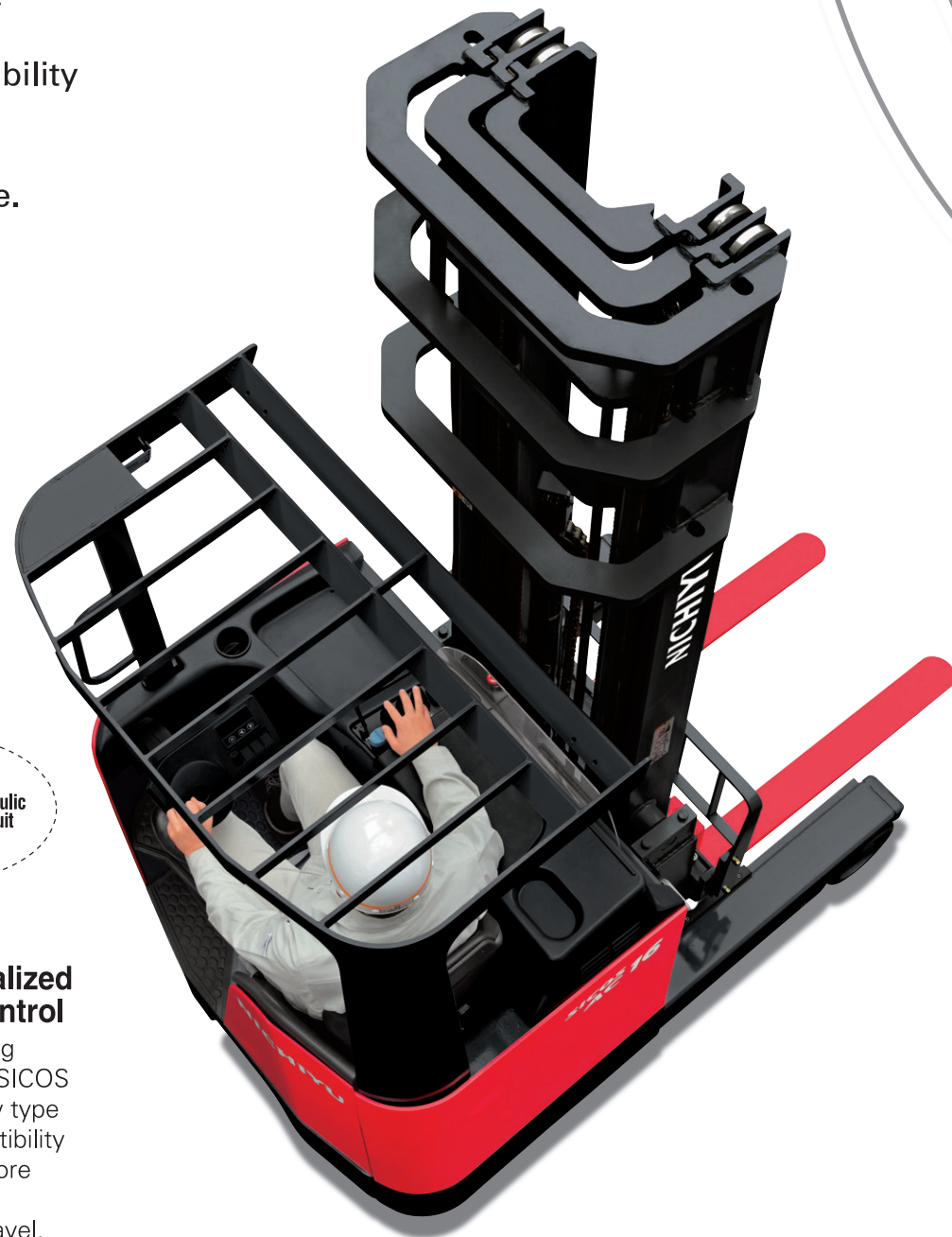

The Multifunctional Centralized Control System for AC Control

SICOS-AC represents the ongoing evolution of the groundbreaking SICOS control system. It features a new type of controller tuned for full compatibility with AC systems and exhibits more powerful and more advanced capabilities. By integrating the travel, hydraulic, and electric power steering functions, the system's advanced intelligence optimizes the operator's interaction with the forklift.

Powerful acceleration for increased work efficiency

Our unique SICOS-AC system provides optimal control of the FBRF's powerful travel and hydraulic AC motors. The result is highly efficient driving, lifting and turning.

Faster Speed

Superior drive performance

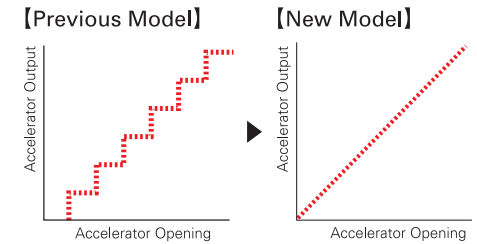

This graph compares the acceleration time and control capabilities of a superceded model and a new model.

Tight Turning

Functional tight turning ability

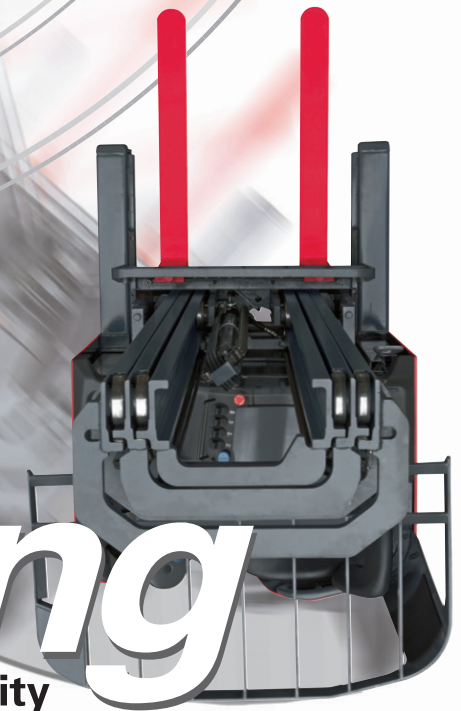

Excellent maneuverability for narrow spaces

By completely redesigning the frame, we've reduced the minimum turning radius and right angle stacking aisle width. As a joint result with newly adopted 360° endless steering, we now lead the industry in space efficiency. At the same time, we've created a more spacious and comfortable operating compartment.

MIN. TURNING RADIUS / PRACTICAL RIGHT ANGLE STACKING AISLE WIDTH (mm)
Clearance: 200 mm

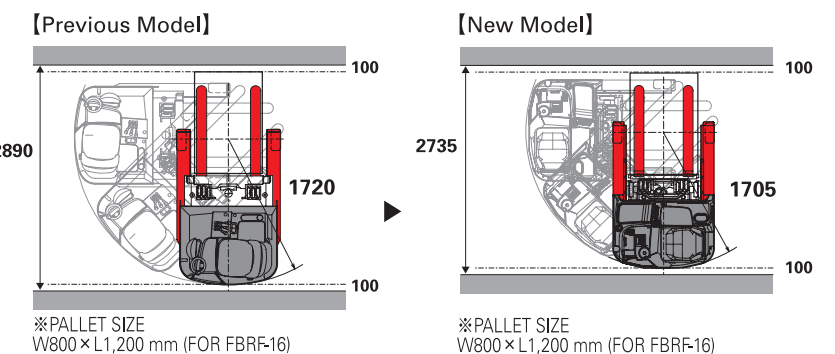



Stable lifting

Dependable stability

Smooth, powerful lifting

We've re-designed chassis and increased mast rigidity to ensure excellent stability even during high lifts. The result is stable load handling at up to seven-meter heights without capacity reduction.*

The tiltable integral sideshifter, provided as standard equipment, improves the efficiency of high loading work.

*when equipped with large batteries

Improved visibility

For safer, easier operation

We've improved the operator's forward field of view by mounting the free lift cylinder diagonally and off-center. What's more, we've carefully designed the overhead guard to avoid blocking the operator's overhead view. These innovations ensure significantly increased work efficiency.



Shock absorption mast and soft landing mechanism

A shock absorption function for the mast relieves any shock occurring from friction while lifting. The speed at which the forks are lowered is reduced just before the forks reach the ground, eliminating any shock. These functions prevent the loads from damage by vibration.

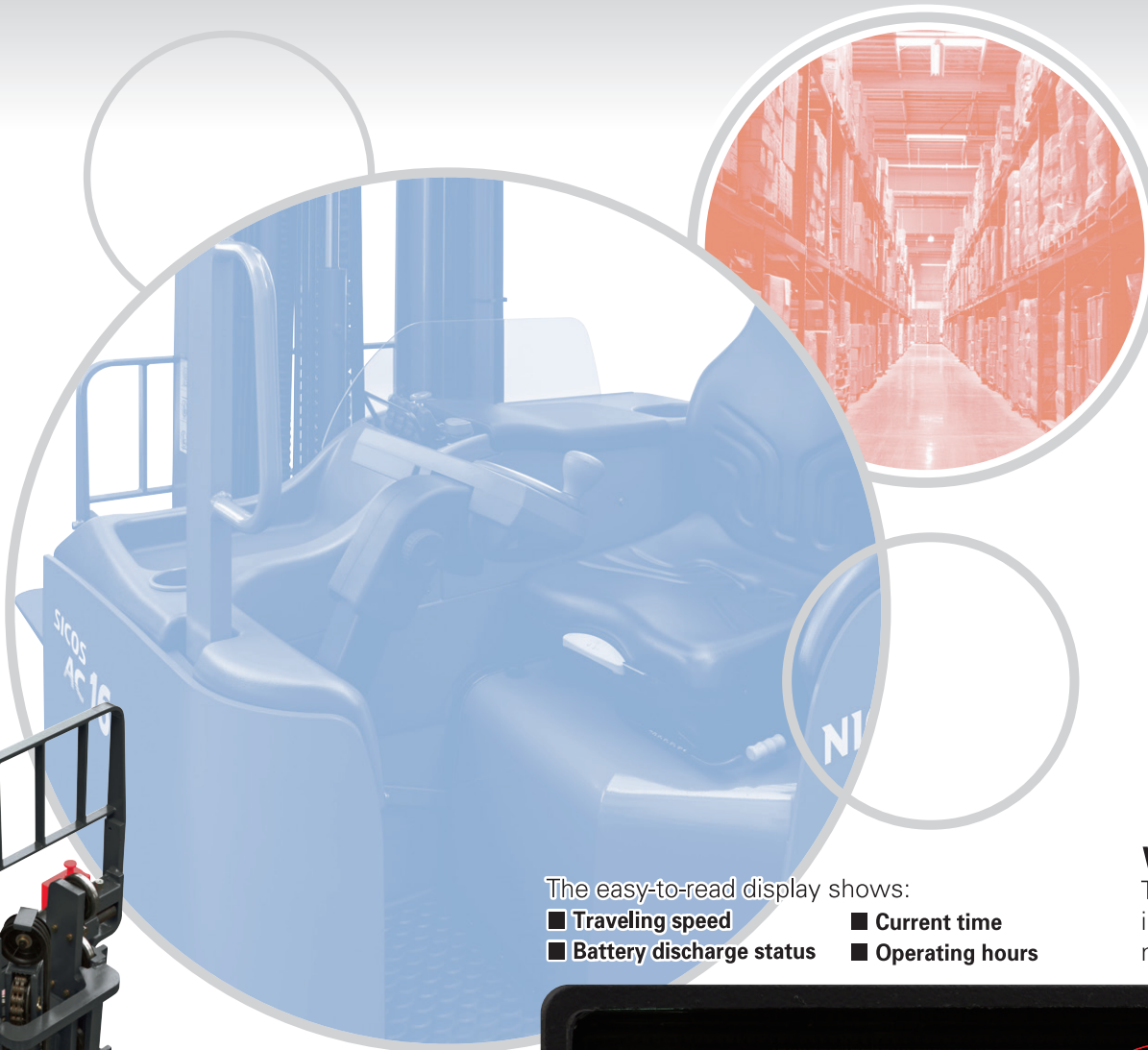
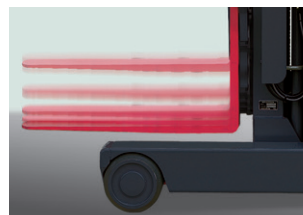

Advanced steering and multi-display



Steer-by-wire with 360° endless steering makes switchback unnecessary. And our speed-sensitive electric power steering (EPS) is easier than ever. What's more, machine status information is put up on the multi-display mounted on steering panel for real-time.

The easy-to-read display shows:

- Traveling speed
- Current time
- Battery discharge status
- Operating hours

Wheel indicator

The wheel indicator on the display instantly shows the direction of truck movement.



Self-diagnosis function

SICOS-AC diagnoses any malfunctions and displays the results with graphics.

Driving mode setting

To accommodate site conditions and the operator's experience level, the operator can set the maximum speed and acceleration feeling on the display.



AOS semi-auto stacking system (Optional)

Once you've entered the heights of your racks into the system memory, the AOS semi-auto stacking system raises the forks to that height at the touch of a button. This feature is a great advantage for loading/unloading your most commonly used racks as well as high racks that are difficult to see.*

*Operator must visually confirm fork position before loading/unloading.

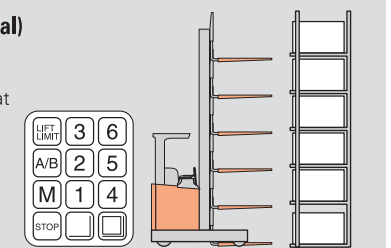

For easy management of multiple functions

Comfortable operation for enhanced ease-of-use

Totally redesigned operating compartment

Our completely redesigned operating compartment features several ergonomic innovations. The tilt-mounted fingertip levers and large armrests greatly reduce arm fatigue. The operator can finely adjust the both of steering panel position and seat position. We've included these advanced features as standard to ensure maximum comfort.



Active safety and easy maintenance

Multiple features for operator safety. Major improvements to everyday usability. And innovations that make Nichiyu trucks a reliable work partner.

Travel-speed-sensitive lift speed control

This innovation automatically slows lift speed and rotation when travel exceeds a set speed. It's an advanced safety feature that helps to prevent accidents.

Automatic power-off

To prevent wasteful power consumption, the power is automatically shut off when the truck is left idle for 15 minutes.

Neutral safety feature Preventing accidents caused by misoperation

The Neutral Safety Feature prevents the truck from moving suddenly if the keyswitch is turned on while the accelerator is depressed or during operation of the hydraulic lever. For preventing accidents caused by misoperation, it issues a warning display and buzzer.

Operation interlock system(OIS)

If the operator is not seated correctly for more than two seconds, traveling and hydraulic operations are interlocked.

Fully opening drive unit cover

The drive unit cover under the operator's seat can be fully opened, providing more convenient access and easier maintenance.



Battery forward pull-out system

Thanks to our convenient mast reach-out feature, the battery can be pulled out toward the front. This greatly simplifies battery refilling and



monitoring of battery electrolyte levels. It also eliminates the need for a battery table.

*To accommodate customers who frequently change batteries, the side roll-out type is also available.

Cold storage applications

These water-resistant, moisture-resistant and rust-resistant trucks are designed to operate at the low temperatures typically found in industrial freezers.

CS class: -20°C continuous exposure**
-35°C intermittent exposure***
FCS class: -35°C continuous exposure**
-55°C intermittent exposure***

60-minute maximum operation time *30-minute maximum operation time



About us

Nichiyu is a pioneering developer of electric forklifts in Japan. Since introducing the country's first electric forklift in 1937, Nichiyu has continued to introduce a variety of innovative electric forklift solutions. We take pride in our ability to provide customer-focused products and exceptional service.

Committed to comprehensive service

We maintain highly trained service staff in every country in which we sell our products. Should you require regular periodic maintenance or emergency repair, simply contact us for fast and efficient on-site service. We take pride in our commitment to first-rate support and unmatched customer service.

All specifications have been determined according to manufacturer's terms and conditions. Specifications are subject to change without notice in the interests of product improvement.

NICHIYU
ELECTRIC FORKLIFT

MITSUBISHI NICHIYU FORKLIFT CO., LTD.

1-1, 2-Chome, Higashikotari, Nagaokakyo-shi, Kyoto 617-8585 JAPAN
URL: <http://www.nmf.co.jp/en/>

CAT No.OSD095/S75-4 Printed in Japan 5000/1412 (TW)