

NICHIYU
ELECTRIC FORKLIFT

15

sicos
Super Intelligent Control System

ELECTRIC FORKLIFT
**COUNTERBALANCED
TRUCKS**
FB-80 SERIES



ELECTRIC FORKLIFT COUNTERBALANCED TRUCKS

FB-80 SERIES

SUPERIOR • TECHN

The Nichiyu FB-80 Series electric forklift is pioneering the future of logistics with its cutting-edge ECO technology. Boasting an intelligent and sustainable energy management system, this eco-friendly electric forklift promises consistent optimal performance. It is equipped with powerful drive technology and superb hydraulics. It is not only economically efficient and reliable, but also excels in safety, stability and ergonomics. The FB-80 Series is pushing boundaries in electric forklift technology and redefining logistics excellence.

ECO Excellence

At the heart of the FB-80 Series forklift lies its industry-leading ECO technology that is clean and efficient. Low energy consumption combines with minimal maintenance and resilient recovery to ensure superb load handling and outstanding drive control.



Energy Efficient:



- **ECO Mode Button:** The ECO Mode optimizes forklift performance, conserving energy for continuous, uninterrupted delivery of high-output tasks with speed and agility.



- **Auto Power Off:** Once idle beyond 15 minutes, the forklift automatically powers down.



- **Regeneration:** A range of integrated regenerative functions enables the forklift to reclaim energy in the following various situations.



Coasting: Energy recovered when the foot is lifted off the accelerator.

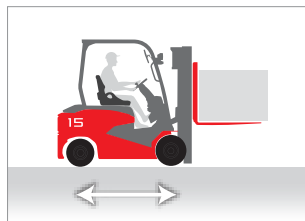

Plugging: Energy recovered when direction change.

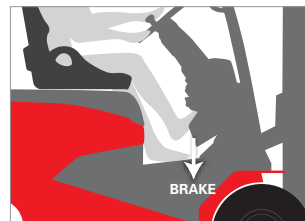

Braking: Energy recovered when engaging the footbrake.



Speed Suppression on Down-slope: Energy recovered when cruising down-slope.





Driving Forward with Green Technology

LOGY



AC Motor

A refined, robust and maintenance-free AC motor powers the truck with formidable lifting prowess, quick responsiveness, and smooth drive performance.

Battery Protection (Option)

An intuitive restriction of lifting power and induced speed reduction immediately alert the operator to the need for re-charging, ensuring battery protection and preservation.

Waterproof Class IPX4

This higher standard waterproof class – with an anti-splash feature that protects against multi-directional water sprays – provides the most robust resistance to external elements.

SUPERB • SAFETY

The FB-80 Series electric forklift

is fully loaded with innovative safety and stability applications that propels it ahead of its class. These features have been meticulously designed to raise the forklift's level of agility and flexibility, leading to higher productivity and output.

Low Center-of-gravity

A low centre of gravity enhances traveling and turning stability, further aided by the deeper emplacement of its battery box.



FB-80 Series

Previous model

Low center-of-gravity
High mount axle

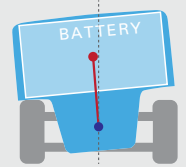
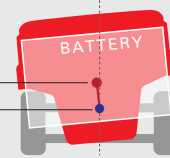

The small movement of the center of gravity during turning enables smooth and safe traveling.



Without Auto Torque Up



With Auto Torque Up

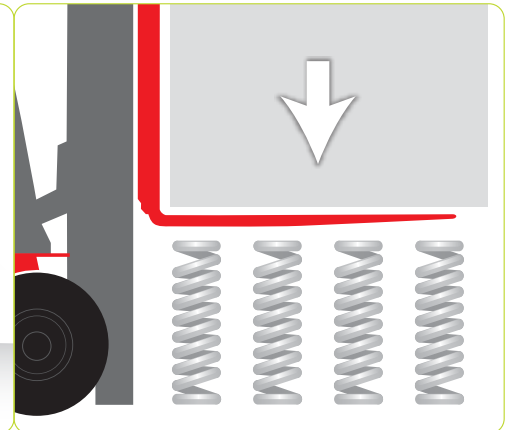
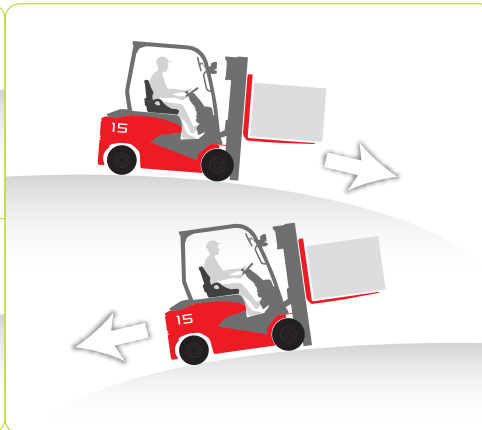

Auto Torque Up

The auto torque up function automatically ramps up the forklift's power when it senses a situational need; for instance, whilst moving up a slope or when carrying heavy loads. Instead of letting the forklift be subjected to a normal drop of output as prompted by the situation, the auto torque up kicks in to maintain regular movement and performance as if the forklift were traveling on a flat surface.

Safety Cruise

The safety cruise limits speed to 1km/h (controlled roll back) and prevents sudden sliding even when the accelerator and brake pedals are released. Additionally, speed suppression is also activated when the forklift is downslope.

Vibration Cushioning (Option)

A hydraulic pressure control system manages pressure levels to accommodate various load capacities. The ability to absorb shocks helps prevent damage to goods when travelling over different terrains.

AND STABILITY



Travel Hydraulic Interlock

This intelligent and sensitive feature disengages all movement if the operator is not seated in the forklift.

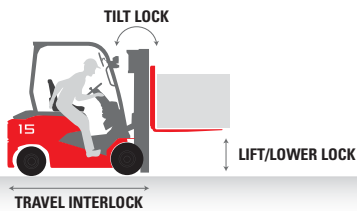

Pitching Control

Pitching control absorbs load vibrations, especially when travelling across bump.

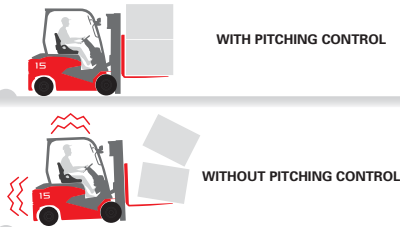

Wide Visibility

Superior multi-directional visibility ensures a clear and broad line of sight.

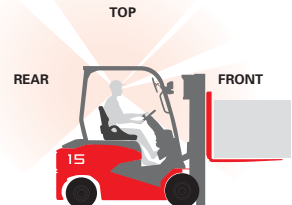

Rear LED Line and Blue Spot Light

The Rear LED Line is an innovative feature that vastly improves pedestrian safety. With the Blue Spot Light that illuminates the forklift's pathway, both these features reinforce safe operations, especially in high-volume locations, noisy workplaces or within confined internal spaces.

Travel, Speed, Lift, and Tilt Control Features

- Turning speed limit: Automatic speed reduction kicks in when turning.
- Speed limiter: A key safety device that manages and limits speed (Option).
- Load weight speed limit: When load capacity is surpassed, speed is instantly reduced (Option).
- Lift height speed limit: The load lift height would induce speed reduction (Option).
- Tilt speed limit at high lift: Tilt speed is reduced according to the height of the load lift (Option).



Other Safety Applications

- **Orange seatbelt:** A brighter colour helps safety managers to better monitor seat belt usage, facilitate effective safety implementation, and ensure user responsibility (Option).
- **Password Entry:** For added security, forklift operation requires an activation password (Option).
- **The emergency stop button** is visible and easily within reach.
- **Audible/visual parking brake warning:** Should an operator leave the forklift without putting on the brakes, audible and visual alerts would prompt him.



OVERLOAD
REDUCE LOAD
Power - [P]
13:28

Load Indicator and Overload Warning (Option)

When lifting is in progress, the load indicator monitors the weight of goods. Should the weight exceed the load capacity, a warning would alert the operator via the display screen.

The load weight indicated is only for reference; it should not be read as the actual weight.



SUPERIOR • FEATU

Outstanding Control and Ergonomics

An immaculate control system ensures the seamless execution of high-intensity load handling with perpetual motion. Creative ergonomics transforms the FB-80 Series into a vehicle that excels in safety, ease and comfort.

Customizable Operation Characteristics

This unique innovation in forklift technology makes the forklift highly versatile through a broad range of customizable operational attributes. The forklift's characteristics can be programmed to suit the operator's skill and experience level, preferred operational style, and functional choices. The customizable functions apply to both traction and hydraulics.

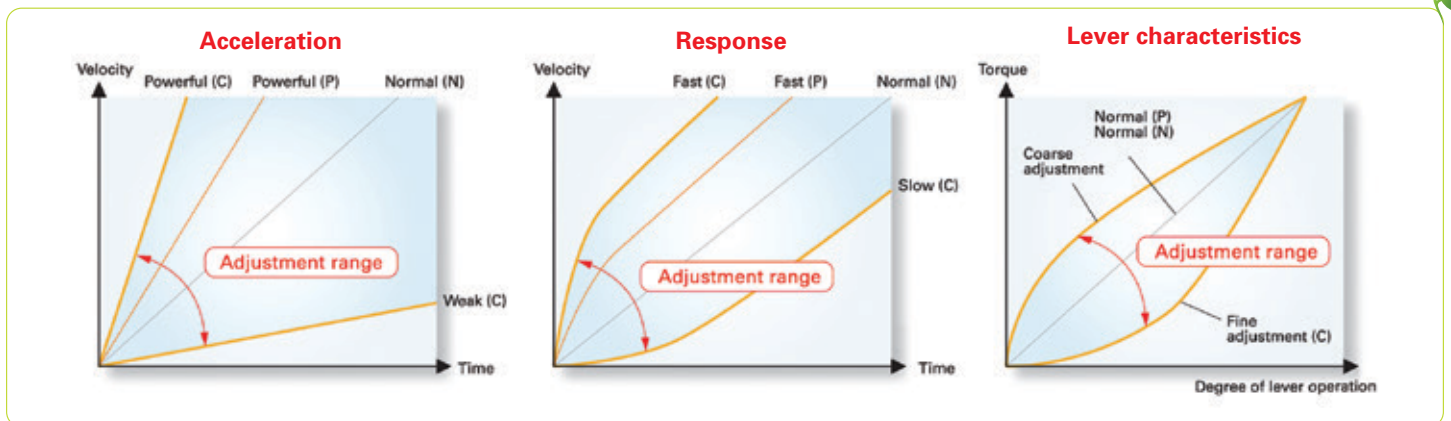

Rear Hand Grip with Horn

Ergonomically placed to reduce fatigue, this grip makes it more comfortable for the operator to shift physically while reversing the forklift. The horn improves safety by alerting pedestrians.



Hydraulic Steering with Synchronizer

Precision hydraulic steering is enabled by an active steering synchronizer that coordinates the alignment between the steering wheel and tire angles through sensors. At all times, the sensors would ensure that the steering knob returns to the original position. This steering feature promises accuracy, consistency, and smooth driving while also enhancing performance and safety.

Hydraulic Steering with Synchronizer



Hydraulic Steering without Synchronizer





Ease of Entry & Exit

Excellent ergonomics makes it easy and comfortable to operate the forklift. Features include a low step height, a wide operator compartment, luxurious head room, and a narrow steering column cover.

LED Lights (Option)

LED lights are available for the head lamp and rear combination lamp. Options include rotating lights or flash lamps. These high-intensity lights are energy saving, durable, cooler, and sturdier.



Dashboard Display

An interactive dashboard display is clearly visible, and provides the operator with key operational details.

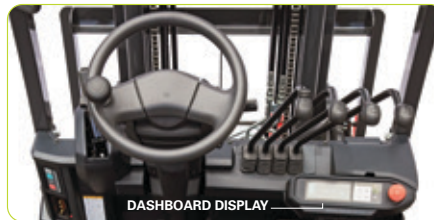

Easy Battery Exchange

The battery compartment is easy to locate, and exchanges are convenient and swift.

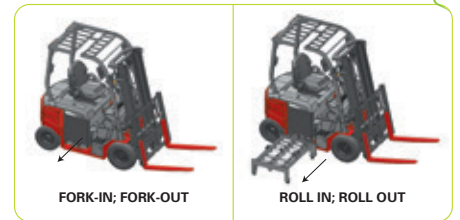

Fingertip Control (Option)

Fingertip control buttons are conveniently and seamlessly embedded within the arm rest, helping the operator to execute tasks with ease.



Optional Features and Parts

The FB-80 Series forklift offers wide-ranging solutions that address multiple logistics scenarios. Apart from standard equipment, the model comes with an impressive inventory of optional features and parts.

- Laser Pointer: Allows operators to position the forks appropriately at high levels.
- Tilt horizontal leveling: The forks automatically stop when they arrive at a horizontal position.
- Front wind shield/ acrylic roof/ rear windshield: Additional shields against wind and rain.
- Attachments: A large inventory of attachments cover multiple applications. These include side shifters, fork adjusters, rotating forks and clamps.
- Cold store: Designed to withstand extremely cold conditions (up to -55° C) when operating in cold rooms. All forklift components are protected from the hazards of condensation that could lead to operations being aborted. Essential fluids used are well secured with anti-freeze solutions.

Standard Specifications

Type	Item		Unit	FB10-80	FB15-80	FB18-80	FB20-80	FB25-80	FBB20-80	FBB25-80		
				Standard type						Long wheelbase type		
Type	Capacity at rated load center		kg	1,000	1,500	1,750	2,000	2,500	2,000	2,500		
	Load center – distance		mm	500	500	500	500	500	500	500		
Dimensions	Height to top of overhead guard		h6	mm	2110	2110	2110	2110	2110	2110		
	Height with mast lowered		h1		1990	1990	1990	1995	1995	1995	1995	
	Lift height		h3		3000	3000	3000	3000	3000	3000	3000	
	Overall height with mast raised		h4		4055	4055	4055	4055	4055	4055	4055	
	Free lift		h2		115	115	115	140	140	140	140	
	Tilt	Forward	α	°	7	7	7	7	7	7	7	
		Backward	β	°	11	11	11	11	11	11	11	
	Ground clearance	Under Mast	m1	mm	110	110	110	115	115	115	115	
		Center of wheelbase	m2		110	110	110	110	110	110	110	
	Front overhang		F		395	395	395	445	445	445	445	
	Rear overhang		C		275	275	315	340	380	340	340	
	Overall length		L1		3150	3150	3190	3375	3415	3535	3535	
	Length to fork face (includes fork thickness)		L2		2080	2080	2120	2305	2345	2465	2465	
	Wheelbase		L3		1410	1410	1410	1520	1520	1680	1680	
	Minimum outside turning radius		R		1850	1850	1880	2030	2080	2215	2215	
	Thread	Front	Single Tire		B5	930	930	925	955	955	955	955
		Rear			B6	900	900	900	965	965	965	965
Overall width		Single	B		1100	1100	1115	1115	1115	1115	1115	
Fork spread – out-to-out	Maximum		B3		920	920	920	995	995	995	995	
	Minimum		B4		240	240	240	260	260	260	260	
Forks	Width		W		100	100	100	122	122	122	122	
	Thickness		T		35	35	35	40	40	40	40	
	Length		L		1070	1070	1070	1070	1070	1070	1070	
Performance	Travel speed	Laden	Pneumatic		km/h	14.0	14.0	13.5	14.0	14.0	14.0	
		Unladen	Pneumatic	16.0		16.0	15.5	16.0	16.0	16.0		
	Lift speed	Laden		mm/s	390	350	330	290	260	290		
Unladen			540		540	540	470	470	470			
Gradeability – laden (3 min. rating)			%	22	19	17	19	16	18	16		
Mass	Service Weight without battery		kg	2060	2190	2420	2895	3270	2965	2965		
	Battery Weight	Minimum	kg	570	600	600	715	810	1025	1025		
		Maximum	kg	875	910	910	1025	1025	1345	1345		
Chassis	Tire size	Front	Pneumatic Single	6.00-9 10PR		21x8-9 14PR	21x8-9 16PR					
		Rear	Pneumatic	5.00-8 8PR			18x7-8 14PR					
	Miscellaneous	Steering type			Full Hydraulic Power Steering							
		Service brakes			Hydraulic							
Parking brakes			Mechanical									
				Hand-operated								
Electrical	Motor	Drive motor (60 min. rating)		kW	7.0	7.0	7.0	8.5	8.5	8.5	8.5	
		Lift motor (10 min. rating)			9.5	9.5	9.5	11.5	11.5	11.5	11.5	
		Steering motor (60 min. rating)			1.5	1.5	1.5	1.5	1.5	1.5	1.5	
Drive / Hydraulic / Steering controls				AC Inverter								
Battery (48V)		STD	Ah/5HR	370	415	415	510	565	725	725		
Charger (3 phase 400/200V)	Type			Automatic Stationary Charger								
	STD		kVA	6.5	6.5	6.5	8.1	8.1	11.0	11.0		

ELECTRIC FORKLIFT

FB-80 SERIES

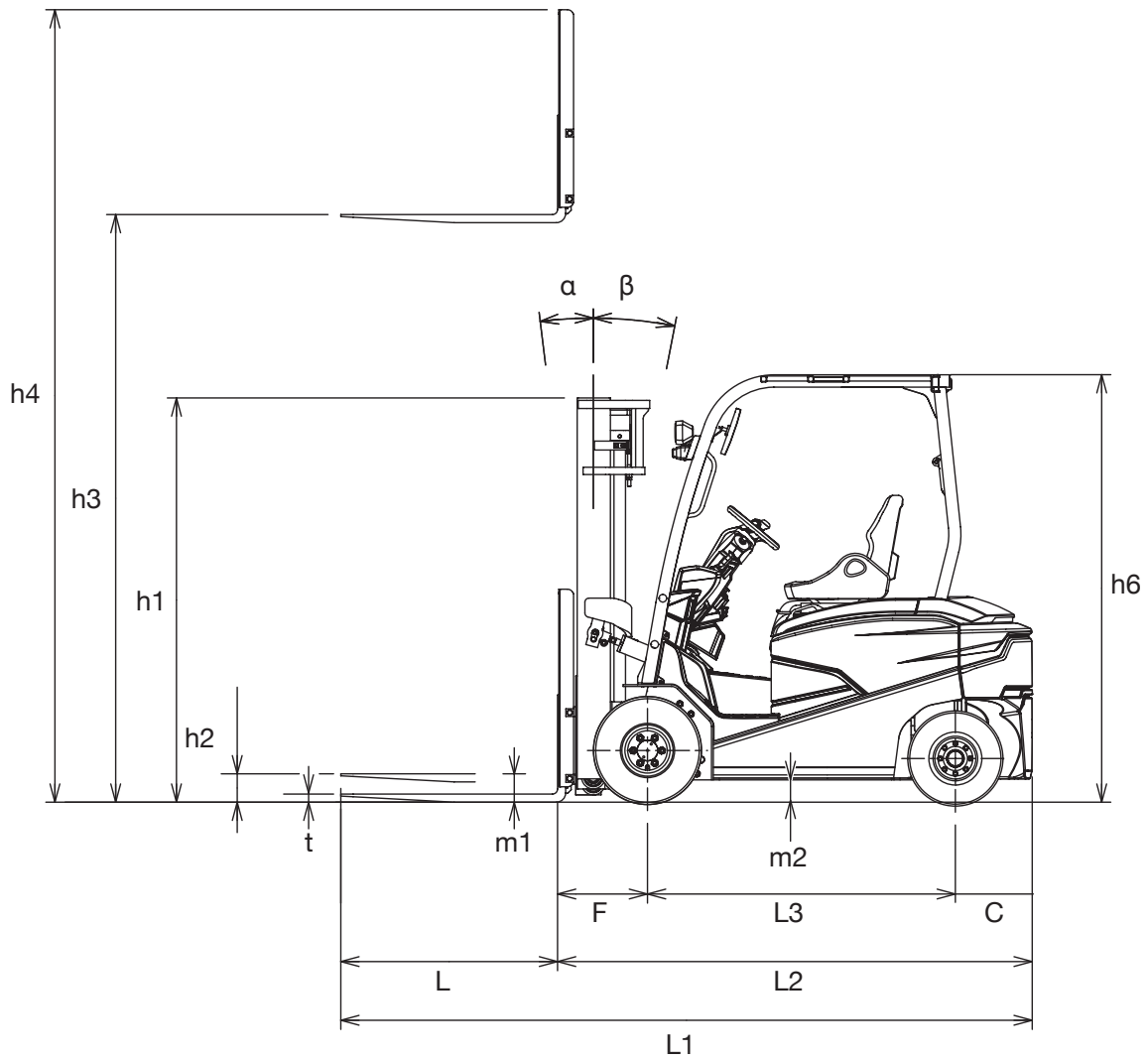
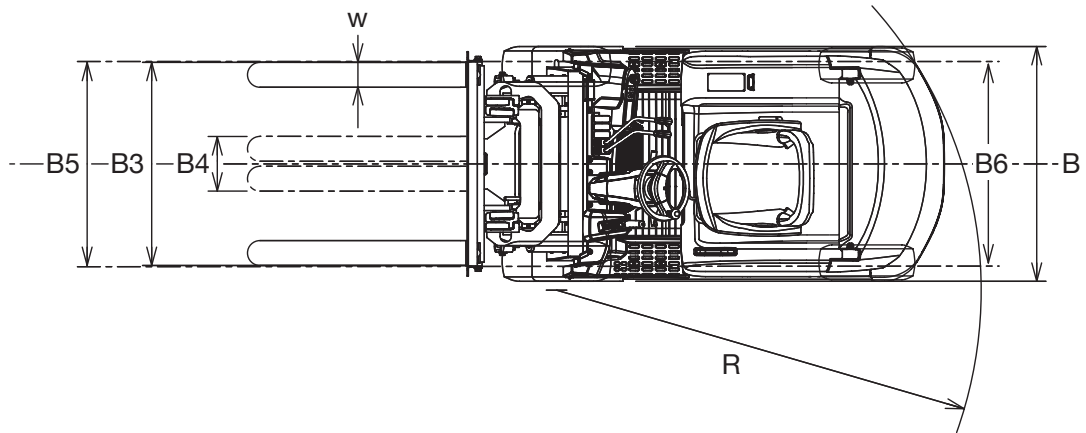



About us

Nichiyu is a pioneering developer of electric forklifts in Japan. Since introducing the country's first electric forklift in 1937, Nichiyu has continued to introduce a variety of innovative electric forklift solutions. We take pride in our ability to provide customer-focused products and exceptional service.

Committed to comprehensive service

We maintain highly trained service staff in every country in which we sell our products. Should you require regular periodic maintenance or emergency repair, simply contact us for fast and efficient on-site service. We take pride in our commitment to first-rate support and unmatched customer service.

All specifications have been determined according to manufacturer's terms and conditions. Specifications are subject to change without notice in the interests of product improvement.