

MOVE THE WORLD FORWARD **MITSUBISHI
HEAVY
INDUSTRIES
GROUP**

GRENDIA EX (4.0 - 5.5 TONS)



FD/FG40N-55N Series

WHEN
RELIABILITY IS
EVERYTHING...

 **MITSUBISHI
FORKLIFT TRUCKS**

mitsubishi
GRENDIA EX
SERIES FORKLIFT TRUCKS

**PERFORMANCE
WITHOUT COMPROMISE**



FG40N

Gasoline engine
Capacity rating 4000kg @ 500mm load center

Mitsubishi Forklift Trucks' new FD/FG40N-55N series

is a whole new breed of forklift truck that's been built from the ground up to meet the demands of users who require heavy duty, robust and reliable machines.

The latest in a series of forklift trucks, the new N-Generation has won accolades from its users for its capacity to work even in the most demanding situations while being friendly to the environment. What's more, these forklift trucks represents the latest in Mitsubishi's transport technology, enhanced safety and commitment to keeping the world green.



FD55N

Diesel engine
Capacity rating 5500kg @ 600mm load center



MADE FOR THE MOST DEMANDING APPLICATIONS

ECO-POWER



POWER DOESN'T MEAN DIRTY

Under the hood of the N-Generation forklift truck is a simple, yet remarkable engine. Mitsubishi Forklift Trucks has developed and refined this robust and reliable power plant while achieving some of the lowest engine emissions in the world. And they've done all this without compromising engine life span, power or ease of maintenance.

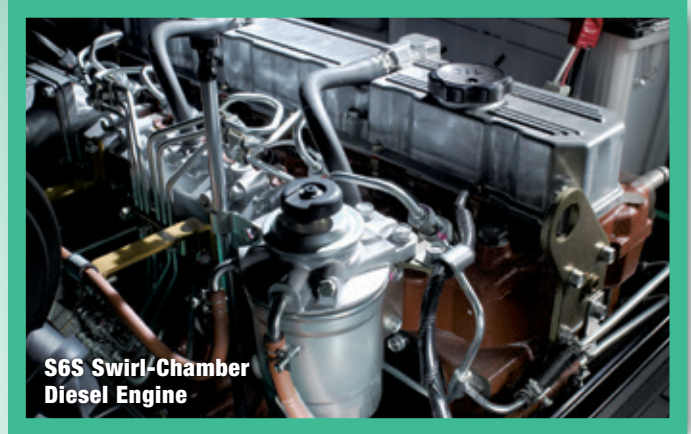

S6S Swirl-Chamber Diesel Engine

HIGHLY RELIABLE DIESEL ENGINE THAT PASSED 2008 EMISSION GAS STANDARD*

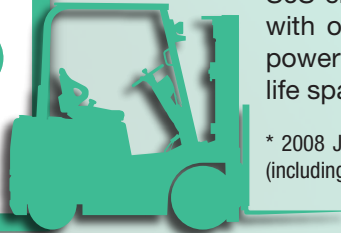
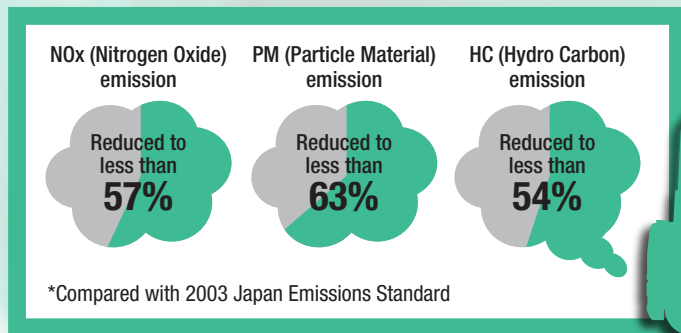

The Mitsubishi S6S high performance engine, NOx, PM, HC emission can be controlled to comply with new environmental standards without adding common rail technology and other options. While low on emissions, S6S engines are designed to be trouble free with only simple maintenance. The result: a powerful, clean operating engine with a long life span.

* 2008 Japan Emissions Standard for Specific Special Vehicles (including off-road)

2007 EMISSION GAS STANDARD COMPLIANT* GASOLINE ENGINE WITH THREE-WAY CATALYTIC MUFFLER

The N-Generation series also has an advanced electronic control system that allows optimum management of its engine, which means lower fuel consumption. To remove environmentally toxic combustion gases a three-way catalytic muffler (standard) has been installed to create higher power yet with lower emissions.



Three-way catalytic muffler

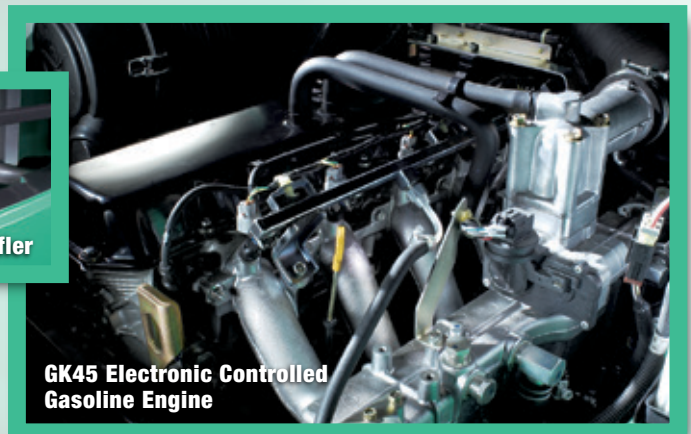

GK45 Electronic Controlled Gasoline Engine

* 2007 Japan Emissions Standard for Specific Special Vehicles (including off-road vehicles)

ONE-TOUCH SWITCH TO ECOLOGY MODE*

"Power/Soft Mode Switch" enables the N-Generation forklift trucks to change between power or ecology priority depending on conditions. Selecting the ecology mode means that CO₂ emissions are decreased by about 13%, a significant reduction of this environmentally toxic greenhouse gas.

* This is an option on diesel engine truck

POWER / SOFT Mode switch

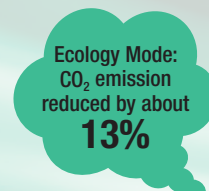

RELIABLE PERFORMANCE



STURDY MAST WITH BETTER VISIBILITY ALL AROUND

Mitsubishi Forklift Trucks' newly designed hardened steel mast rail is extremely strong and resists twisting and bending under loads that would cripple some forklifts. The mast also incorporates trouble free ball-type bushings. These bearings give the mast a longer life span and a longer service interval. Besides the optimum positioning of the mast itself, the main mast's cylinder and chain have been placed out of the way for even better driver vision. Better vision means better safety.



SOLID FRAME & LOW CENTER OF GRAVITY DESIGN

The latest stress analysis techniques, together with proven Mitsubishi Forklift Trucks manufacturing technologies, have created a long-lasting frame and body with a low centre of gravity. This translates into better performance and enhanced stability when doing heavy work or carrying heavy loads.



EXCELLENT BODY BALANCE AND REAR VIEW

Designed not only to look good, N-Generation series forklift truck's new sharp form V-shaped counterweight provides exceptional stability and balance while allowing for an easier rear view, as well. The more a driver can see means better workplace safety and fewer accidents.



STEEL NOT PLASTIC

All N-Generation forklift trucks incorporate a wide, open step made from steel, not fibreglass, into its cab design. A steel step increases durability, prevents slipping and won't crack under pressure like plastics can.



EFFECTIVE COOLING SYSTEM

All N-Generation forklift trucks are fitted with a large, heavy-duty radiator core. The radiator's low noise cooling fan along with optimum placement of the muffler make for a highly effective cooling system. Effective cooling translates into longer engine life and less downtime due to overheating.

TOUGH BASE AREA TO SUPPORT HEAVY LOADS

Double pin sealing and a one-piece cast housing creates a stronger, tougher forklift truck base. A tougher base provides added protection and support when carrying heavy and demanding loads.

EASY OPERATION DRIVER COMFORT

MITSUBISHI FORKLIFT TRUCKS OFFER THE BEST OF BOTH WORLDS: COMFORT & SAFETY.

FD/FG40N-55N series cockpits are designed with operator safety in mind and incorporate the maneuverability, comfort and safety that professional have come to expect from Mitsubishi Forklift Trucks.

To improve operator comfort while reducing strain and fatigue, the forklift truck is fully equipped with advanced features that make operating a N-Generations series forklift truck less tiring and more productive than ever.

PRODUCTIVITY AND COMFORT FEATURES



100% Full Hydraulic Power Steering

Equipped with cornering and steering knob to help prevent accidental steering slippage.



Combination Switch

Turn signal and headlight switches are combined as in passenger car.



Electric Shift Lever

Forward / neutral / reverse shift operation is easy with the touch of a finger.



Suspension Seat with Hip Support Function

Sliding and reclining mechanism to improve comfort and reduce fatigue.



Foot Operated Inching Pedal

Wide foot space and better foot pedal position for precise control.



New Transmission

Forward 2-speed / Reverse 1-speed automatic transmission.

POWER LINE FULL-FLOATING DESIGN

The entire power train, from engine to transmission is secured to the frame by rubber mounts. These specially designed mounts absorb vibration, and make for quieter, smoother forklift truck operation.

ACTIVE SAFETY

AUTOMATICALLY "SAFE" ONCE YOU LEAVE THE SEAT

To avoid the risk of accidents, Mitsubishi Forklift Trucks' unique vehicle Integrated Presence System "IPS2" has been incorporated into all FD/FG40N-55N series models. The system automatically disengages and locks forklift operation when operator leaves the seat. Such a system helps to ensure safety and prevent accidents to operators, colleagues and customers alike at the workplace.



INTEGRATED MONITOR

Digital display allows excellent vision, from travel speed, gross load and other operating conditions. The monitor easily shows engine and forklift truck operations at a glance.



TRAVELLING SPEED INDICATOR

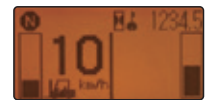

PARKING BRAKE AT THE SEAT-CONNECTED INTERLOCK

Another safety improvement to the N-Generation series of forklift trucks is the integral interlock system. Once an operator leaves the seat, not only the mast and travel functions are locked, but the parking brake is engaged as well.

* Truck speed less than 1km/hr

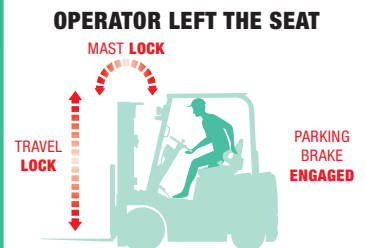

SAFETY SYSTEMS TO AVOID OPERATION ERROR

The fork on the forklift truck is automatically locked when the ignition is switched off, so it remains in position even if the lift lever is accidentally bumped or moved. A Neutral Safety lock is also installed to prevent the machine from sudden travel if the engine is accidentally started while in gear.

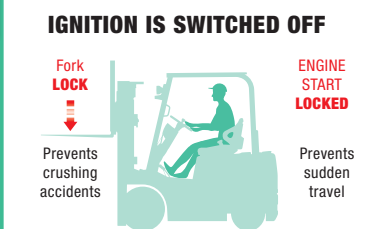

HIGH-MOUNTED REAR COMBINATION LAMP

This rear combination lamp that provides clear brake, reverse and turn signals to vehicles or persons behind the forklift truck.

SOFT LANDING

This unique feature automatically slows down the forks when approaching the ground, protecting valuable goods from hard drops or shocks.

* Only for two-stage simplex masts.

MAINTENANCE

MITSUBISHI FORKLIFT TRUCKS ASSURES OWNERS OF EASY MAINTENANCE AND A LOW RUNNING COST

Longer service intervals mean that a vehicle can be used more often, saving valuable time and money. Operators and owners will find the N-Generation series of forklift trucks easy to maintain and manage.

WELL-PLACED MAINTENANCE POINTS

The N-Generation series forklift trucks have an engine cover that opens fully along with easy-to-remove side panels. The maintenance points are easy to access and they are strategically placed to allow quick inspection or maintenance.

EASY MAINTENANCE AROUND RADIATOR

An easy to open half-split cover makes radiator inspection and maintenance a snap.

IMPROVED BRAKE DESIGN

A newly designed, easy-maintenance braking system that does not require hub and drum removal is installed as standard equipment. The work, time and cost required for service are substantially reduced when compared to previous models.

SIGNIFICANT EXTENSION IN SERVICE INTERVAL

Service intervals for the changing of engine oil has been more than doubled from 200 hours to 500 hours.



Oil change cycle

With Mitsubishi Forklift Trucks recommended engine oil

Conventional vehicle

200 hours

FD/FG40N-55N series

500 hours

* Depends on diesel fuel sulphur content.

MITSUBISHI FORKLIFT TRUCKS ARE HIGHLY CUSTOMIZABLE TO SUIT JUST ABOUT ANY APPLICATION AND WORKPLACE ENVIRONMENT

The FD/FG40N-55N series forklift trucks' unsurpassed performance is ideal for many industries where quality, dependability and heavy duty tasking is involved. Mitsubishi Forklift Trucks offers a line-up of attachments and options to suit just about any need.



FORKLIFT TRUCK FOR THE PAPER INDUSTRY

Capable of handling paper rolls effectively. Capable of handling small-diameter paper roll with a movable short arm. Improved contact pads provides better grips on rolls. Capable of handling two rolls of paper with different diameters (Special Request Option).

- Attachment installed: Roll Clamp
- Mast installed: Heavy Duty Mast
- Recommended option: Hydraulic Oil Cooler



FORKLIFT TRUCK FOR THE RECYCLED PAPER INDUSTRY

Excellent insert clamp-arm to grip paper bales safely and securely. Wide view between clamp cylinders.

- Attachment installed: Bale Clamp
- Recommended option: Hydraulic Oil Cooler / Semi-under Net Kit



FORKLIFT TRUCK FOR THE TIMBER INDUSTRY

This forklift truck has a hinged fork and back rest to scoop and carry logs and sawn timber.

- Standard: Panoramic Hinged Fork (fixed type back rest)
- Recommended option: Air Intake Pre-Cleaner / Front Windshield / Dust Proof Net for Radiator



FORKLIFT TRUCK FOR THE QUARRY INDUSTRY

This forklift truck has a hinged fork and fixed back rest that can move and carry stone without damage. It provides excellent handling and grip, even in bad road conditions.

- Standard: Panoramic Hinged Fork (fixed back rest)
- Recommended option: Air Intake Pre-Cleaner / Front Windshield / Dust Proof Net for Radiator

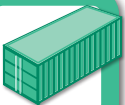

FORKLIFT TRUCK FOR THE MARINE / PORT INDUSTRY

This forklift truck is designed to work in confined spaces such as inside vessels or containers. The three-stage full free mast has a wide front view, and it can be used for high shelves loading — making full use of cargo space.

- Standard: Wide view Three-stage Full Free Mast
- Recommended options: Diesel Particulate Filter / Front Windshield



SPECIFICATIONS

CHARACTERISTICS					DIESEL ENGINE TRUCK				
1	Type of Truck				FD40N		FD45N		
2	Model				3500	4000	4000	4500	4500
3	Loading Capacity		kg		600	500	600	500	600
4	Load Center		mm						
PERFORMANCE									
5	Maximum Fork Height		mm	A	3350				
6	Free Fork Height		mm	B	150				
7	Speeds	Lifting	Loaded	mm/s	550				
			Unloaded	mm/s	610				
		Lowering	Loaded	mm/s					
			Unloaded	mm/s					
8	Tilt	Mast	Forward	deg					
			Backward	deg					
9	Speeds	Travelling	Loaded	km/h	21.5				
			Unloaded	km/h	22.0				
10	Maximum Drawbar Pull	Stall	Loaded	N	37500		36500		
		Drawbar Pull	1.6km/h	Loaded	N	27000			
11	Maximum Gradeability	stationary on slope	Loaded	%	44.9	42.5	39.4	37.4	35.5
			Gradeability	at 1.6km/h	Loaded	%	31.1	29.1	28.0
12	Turning Radius		mm	C	2580		2730		
13	Practical Intersecting Aisle Width	Single	with 1220mm forks	mm	2320		2395		
14	Practical Aisle for Right Angle Stacking		with 1220mm forks	mm	4370		4530		
DIMENSIONS									
15	Overall Length to fork Face		mm	D	3000		3130		
			mm	E	1415				
16	Width	with Standard Tires	mm						
		with Normal Duals (Optional)	mm						
		with Special Duals (Optional)	mm						
17	Height	with Lowered Mast	mm	F	2320				
		with Extended Mast (with backrest)	mm	G	4570				
		to top of Overhead Guard	mm	H					
			mm	I	50x150x1220				
18	Forks (Thickness x Width x Length)		mm	J					
19	Forks Spread (Out-to-Out Minimum / Maximum)		mm	K	577				
20	Front Overhang (Center of Front Axle to Fork Face)		mm	L	1850		2000		
21	Wheelbase		mm	M					
		Front, standard tires	mm						
		Front, Normal duals (Optional)	mm						
		Front, special duals (Optional)	mm						
22	Tread Width	Front, standard tires	mm	N					
		Rear tires	mm						
23	Ground Clearance	at Lowest point outer mast	mm						
		at Center of Wheelbase	mm						
24	Tire Size	Size Front, standard			8.25-15-14PR				
		Size Front, Normal dual (Optional)			7.50-16-12PR				
		Size Front, special dual (Optional)							
		Rear tires			7.00-12-12PR				
WEIGHT									
25	Machine Weight	Powershift (standard) Tires	kg		5920		6330		
		Powershift (optional dual) Tires	kg		6050		6420		
		Powershift (special dual) Tires	kg		6120		6490		
BRAKE									
26	Service Brake Type								
27	Parking Brake Type								
POWERTRAIN									
28	Engine	Model			S6S				
		Max. Rated Power / rpm to DIN 70020	kW / rpm		57.5 / 2300				
		Max. Rated Torque / rpm to DIN 70020	Nm / rpm		260 / 1700				
		Displacement	cc		4996				
		Fuel Tank Capacity	L		87				
29	Transmission	Type							
	Number of Speed	Forward							
		Backward							
30	Relief of Pressure	For Attachments	Mpa						

GASOLINE ENGINE TRUCK											
FD50CN	FD50N	FD55N	FG40N		FG45N		FG50CN		FG50N	FG55N	
5000	5000	5500	3500	4000	4000	4500	4500	5000	5000	600	
500	600		600	500	600	500	600	500	600		
3360			3350			3360			3360		
160			150			160			160		
470	570				490				490		
530	600				520				520		
500			500			500			500		
6			6			6			6		
21.0			22.0			21.5			21.5		
22.5			22.5			22.5			22.5		
37000	26000		38500		27500		37500		27000		
26500	30.1		28000		36.2		37500		27000		
33.9	32.3	30.1	45.8	43.3	40.2	38.1	36.2	34.6	33.0	30.7	
23.8	22.6	20.8	32.0	30.1	28.9	27.2	25.9	24.5	23.3	21.5	
2760	2890	2940	2580		2730		2760		2890		
2415	2470	2495	2320		2395		2415		2470		
4560	4710	4760	4370		4530		4560		4710		
3170	3310	3360	3000		3130		3170		3310		
1460			1415				1460				
1780			1965			1780			1965		
2400	4590				2320		2400				
	4590		2250		4570		4590		4590		
	60x150x1220		2250		50x150x1220		60x150x1220		60x150x1220		
582	602	300-1190	577		2000		582		602		
	2150		1850				2150		2150		
1175			1310			1445			1180		
150			227								
300-15-18PR		N/A		8.25-15-14PR		7.50-16-12PR		300-15-18PR		N/A	
		8.25-15-12PR		7.00-12-14PR		7.00-12-12PR				7.00-12-14PR	
6850	7300	7640	5860		6270		6780		7240		7570
6930	7390	7720	5980		6350		6870		7320		7660
7000	7460	7790	6060		6430		6940		7400		7730
Hydraulic											
Hydraulic											
GK45											
(GAS) 63.9 / 2450											
(LPG) 72.1 / 2450											
(GAS) 265 / 1600											
(LPG) 288 / 1600											
4452											
105			87			105			105		
ATM (TORQUE CONVERTER)											
2											
1											
19.1											

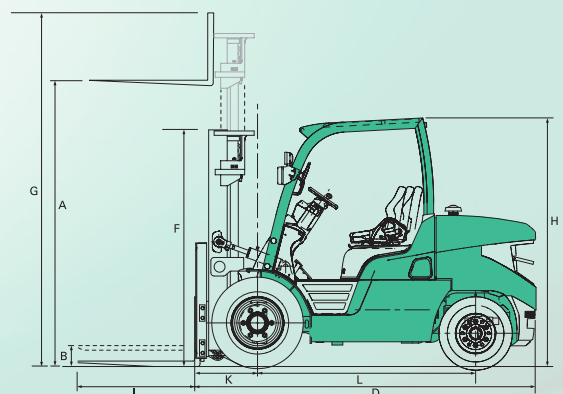
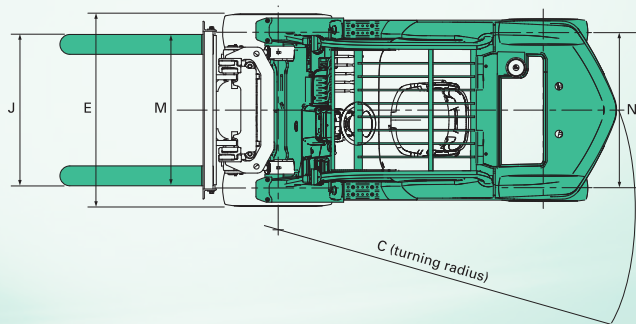

Like any product bearing the "MITSUBISHI" name our materials handling equipment benefits from the tremendous heritage, huge resources and cutting-edge technology of one of the world's largest corporations – Mitsubishi Heavy Industries Group.

Engineering spacecraft, jet planes, power plants and more, MHI specialises in those technologies where performance, dependability and superiority decide your success or failure...

So when we promise you quality, reliability and value for money, you know it's a guarantee we have the power to deliver.

That's why every model in our award-winning and comprehensive range of lift trucks and warehouse equipment is built to a high specification – to ensure it keeps working for you. Day after day. Year after year. Whatever the job. Whatever the conditions.

YOU'LL NEVER WORK ALONE

As your local authorised dealer, we are here to keep your trucks working – through our extensive experience, our technical excellence and our commitment to customer care.

We are your local experts, backed by efficient channels to the entire organisation of Mitsubishi Forklift Trucks.

No matter where you are, we are close by – with the capability to meet your needs.

Discover how Mitsubishi Forklift Trucks give you more from your local authorised dealer or when you visit our website www.mitforklift.com.sg

Performance specifications may vary depending on standard manufacturing tolerances, vehicle condition, types of tyres, floor or surface conditions, applications or operating environment. Trucks may be shown with non-standard options. Specific performance requirements and locally available configurations should be discussed with your distributor of Mitsubishi forklift trucks. We follow a policy of continual product improvement. For this reason, some materials, options and specifications could change without notice.

© 2022 by MLAP. All Rights Reserved. All registered trademarks are the property of their respective owners. Printed in Singapore.

FMIT0146-02 (03/2022)

