

**HELI**

*“Lifting the Future”*

**12-16 t**

**G Series Heavy Forklift**



[www.mlaholdings.com.au](http://www.mlaholdings.com.au)

# NATIONAL

---

# INFRASTRUCTURE

MLA Holdings Pty Ltd was established in 1980 with Mitsubishi Heavy Industries, for the sale and distribution of Mitsubishi Forklift Trucks in Australia.

The company has been operating in Australia since then for 41 years and now has core business in the sale, hire and service support of materials handling equipment Australia wide.

The MLA distribution network is Australia wide with offices in New South Wales, Queensland, South Australia, Western Australia, and Victoria. Recent company acquisitions have seen MLA's branch network grow into the Gold Coast and Newcastle Regions, through Classic and Hunter MLA.

We are the exclusive Australian distributor of three complementary brands – Mitsubishi and Nichiyu Forklift Trucks and MLA Vulcan Equipment that includes pedestrian, all-terrain and standard forklifts complemented with a range of HELI Heavy Forklifts and Container Handlers.

Throughout the company's growth, MLA Holdings Pty Ltd remains a privately-owned business.



## Why HELI

HELI heavy-duty industrial forklift trucks provide performance, reliability and dependability in the most arduous of applications. Featuring a luxury cabin with suspension seat and ergonomic fingertip controls and a Hi-Vis upright design HELI is designed to deliver the highest levels of productivity and operator comfort.

This machine is built tough to handle most demanding jobs, with truly innovative solutions to make your operation run smoothly. A continuous product development program and sophisticated technological advances means cost of ownership is significantly reduced.

HELI Heavy Forklifts are ergonomically designed for unsurpassed operator comfort. Excellent visibility, an air suspension seat, climate control and ventilation provide an optimal environment for operators. Instrumentation and displays are conveniently arranged, and the joystick control offers fine adjustment to accommodate the most discerning operators.

The HELI Heavy Forklifts fully complies to Australian Standards AS2359

## World Class Drive Train

The Cummins QSB6.7 Tier3, Stage IIIA engine takes your forklift to a whole new level of power, versatility and emissions control. It achieves Tier 3 and Stage IIIA compliance with in-cylinder technology that maintains a compact and simple installation that provides premium performance to every application.

The ZF-Transmissions 3 WG-131/171 are composed of a hydrodynamic torque converter and a rear-mounted multi-speed powershift transmission with an integrated transfer case delivers smooth and responsive travel. Meritor and Kessler drive axles are characterized by a superior reliability based on many years of field experience. The modular design combined with wet disc brakes and outboard planetary gears provide unsurpassed durability and life.

## MLA Product Support

With MLA you work with an experienced customer focused team of professionals. MLA has a fleet of mobile service technicians available within each of our seven owned and operated branches nationwide.

MLA has the people, total product solution, national service capability, and proven commitment to deliver the highest quality, safety and environmental standards to meet the material handling requirements of customers across all industry types.

We have the expertise to service and maintain every make and model of forklift available in the Australian marketplace.

All preventative maintenance will be conducted by MLA technicians and scheduled at convenient times to suit each customer site operation.

The service administration process is managed and performed applying our ISO 9001:2015 quality assurance procedures, in conjunction with OEM's (Original Equipment Manufacturer) manufacturer's recommendations.

MLA will provide 24 hours per day and 7 days per week response as required.

At MLA, our goal is to keep your forklift running at optimal performance levels with ownership costs down. We know that imitation forklift parts can lower the performance or maybe damage the equipment MLA supplies – that's why we offer genuine parts supplied by the OEM (Original Equipment Manufacturer). MLA field technicians are trade qualified, factory trained and equipped with the right tooling to carry out their work safely and efficiently.

# A Enduring and durable

## A.1 Durable structure design

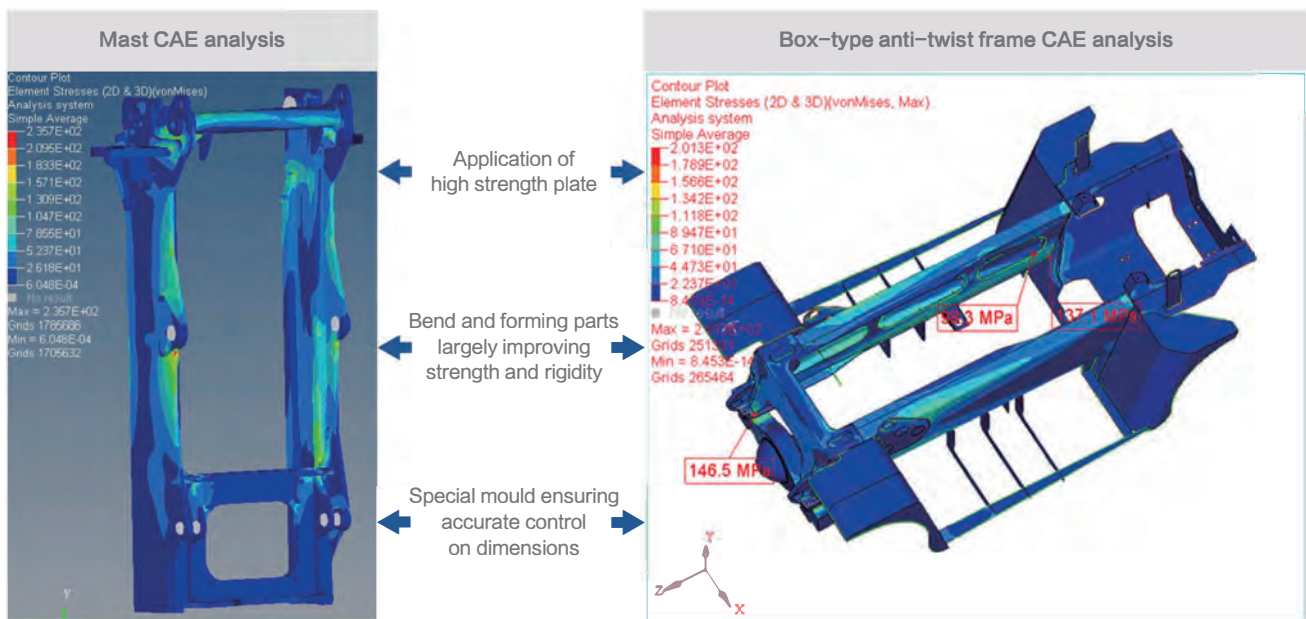

## A.2 Easy and high efficient daily inspection

- ▶ Cab electric tilting system**  
 Automatic tilting system facilitates under bonnet maintenance; Hydraulic motors and tilt cylinders with electric assistance makes the cabin tilt 60° rightward which makes maintenance easy.
- ▶ Engine hood with large opening angle**  
 Open type engine hood which can be open through two self-locking springs ensures easy and highly efficient maintenance.



- ▶ **Daily Maintenance and prestart checks.**  
Checking and topping oils, coolant with safety is simple.

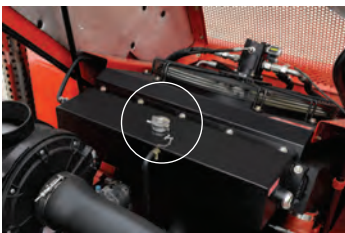

- Convenient coolant checks



- Easy access to diesel top up



- Visual hydraulic oil level (hydraulic oil level gauge)

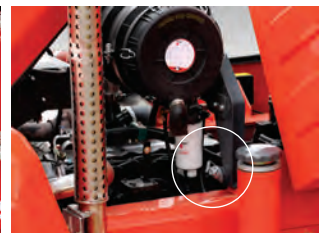

- Oil-water separator
- Easy engine oil adding and check

## A3 Improved component protection

- ▶ Oil cylinder protection sleeve
- ▶ Electric tilting button, dust-proof and water-proof
- ▶ Improved harness protection
- ▶ Dust-proof and water-proof plus and sockets
- ▶ Dust-proof vent
- ▶ High strength aluminum plate fin type radiator
- ▶ Improved fuel pipe safety



■ Oil cylinder protection sleeve (optional)



■ Electric tilting button with high dust-proof and water-proof degree: protecting degree: IP67



■ Front axle dust proof vent



■ Transmission box dust proof vent



- ▶ High strength fin type structure will not deform or crack easily.
- ▶ Exterior injection molding treatment anti-corrosion and oxidation resistance.



- Dust-proof sleeve for electric cabinet



- Molding steel pipe is used for oil suction pipe improving safety.

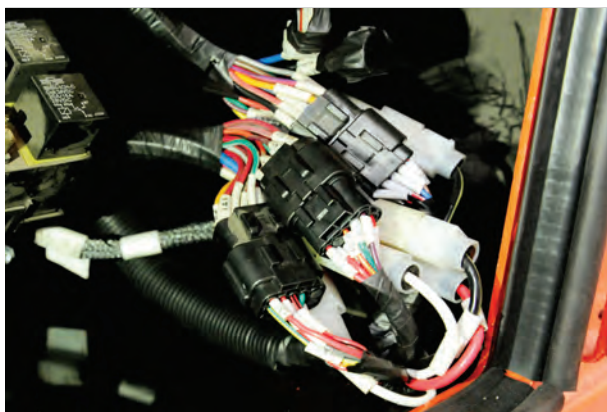

- Dust proof and water proof sockets and plugs: protection IP65



- Harness meets German standard and its temperature resistance ability is largely improved (-40°C - 105°C)

#### A4 Improved cooling efficiency

- ▶ Optimal designed channel
- ▶ Reasonable layout of radiator's fins
- ▶ Optimal designed fan



- **Optimal designed channel**  
Optimal designed radiator and channel make cooling system have small resistance, avoid air flowing back effectively and improve cooling efficiency.

- **Optimal designed fan**  
Axial fan with multiple blade, enough blast capacity and pressure and consume power is special for G series based on a large number of comparative tests.





# B Energy saving and environment friendly

## B.1 High efficient matching, forceful power

### ► Cummins QSB6.7 engine

The Cummins QSB6.7 Tier3, Stage IIIA engine takes your forklift to a whole new level of power, versatility and emissions control. It achieves Tier 3 and Stage IIIA compliance with in-cylinder technology that maintains a compact and simple installation that provides premium performance to every application.



### ► ZF transmission box

Smooth gear shifting without shock. Intelligent gear shifting mode is easier. High efficient power match is more energy saving.



## B.2 Load sensing hydraulics

- The load sensing system adjusts oil pump displacement automatically according to the required load conditions producing a powerful and smooth operation. For models CPCD140-C1Z-09IIIIG and larger.

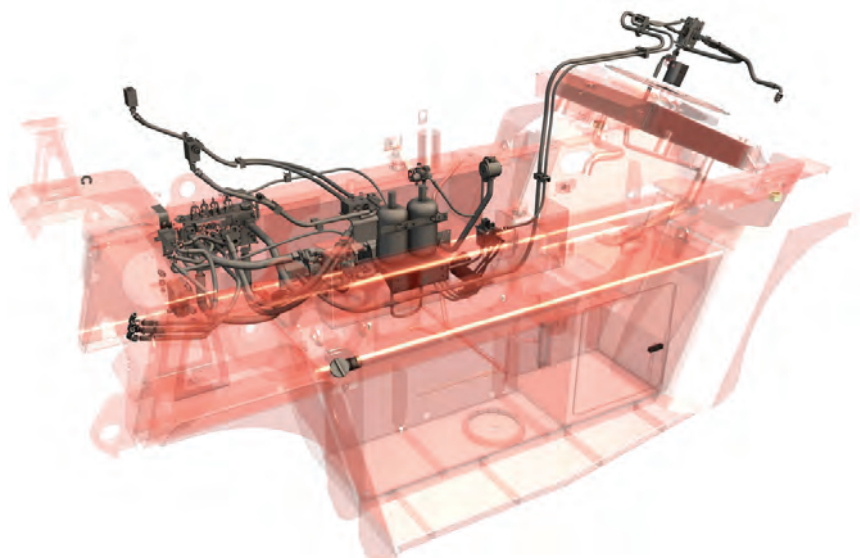

### B.3 Intelligent cooling system

- ▶ The four in one compound radiator effectively integrates cooling resource and saves space.
- ▶ Real time thermal management system monitors the temperature curve by way of the variable speed hydraulic cooling fan.
- ▶ The variable speed cooling system uses 10% less energy with an outstanding reduction in noise.



#### Intelligent sensitive thermal management system

##### ▪ Electric control system

Real time thermal managing system monitors cooling medium temperature curve of the completed truck to control fan speed.

##### ▪ Hydraulic system

Fan is powered by separated power which is different from traditional direct connection fan to achieve fan multilevel speed changing.

##### ▪ Cooling system

Four in one compound radiator; optimized air channel and fan the air duct and the fan.

## B.4 Counterweight design

- ▶ The intelligent cooling system doesn't require air flow through the counterweight.
- ▶ Counterweight structure and mass is optimised.



### ■ Counterweight no air channel design

The improved counterweight design allows optimal weight distribution that results in superior stability when lifting loads.



### ■ Chassis design

Application of high strength material.  
Years of data accumulation and accurate GAE analysis.  
Constant structure optimization.

# C/ Comfort and convenient



## C.1 Easy access

- **Large full length stairs and handrail**  
Open type steps make it easy and safe to get on-off.
- **Anti-skid stairs**  
Anti-skid aluminum stairs reduce the risk of slips.
- **Auxiliary handrail**  
Solid and durable.

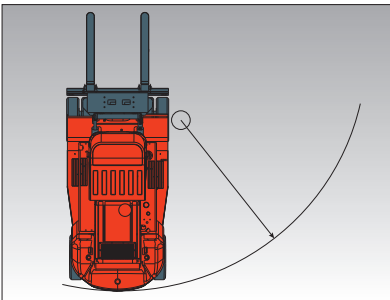

## C.2 Smaller turning radius

- **Smaller turning radius**  
Compact frame design.  
Optimized steering angle.



## C.3 Mast - lift circuit accumulator

- **Mast lower buffering**  
Reduces the shock when lowering the load.



## C.4 Superior operator visibility

- **Superior front view**  
Front glass with large arc is used and front view field angle is increased by 10°.
- **Superior top view**  
Large glass is used on the top of cab.
- **Superior rear view**  
1200mm x 900mm glass is used at the rear end of cab.
- **Glass for left and right-side window**  
Four pieces of glass are used on left and right door to ensure 360° view.
- **Professional ergonomics view analysis**



- **Rear vision system (optional)**  
Truck real time rear view can be displayed when backward.

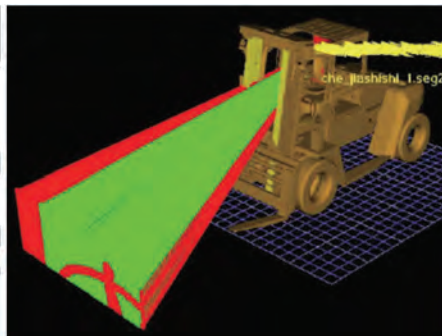

- Front view check

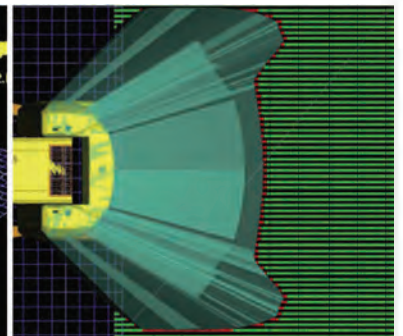

- Rear view check



### C.5 More comfort driving experience

Special cab with 360° view

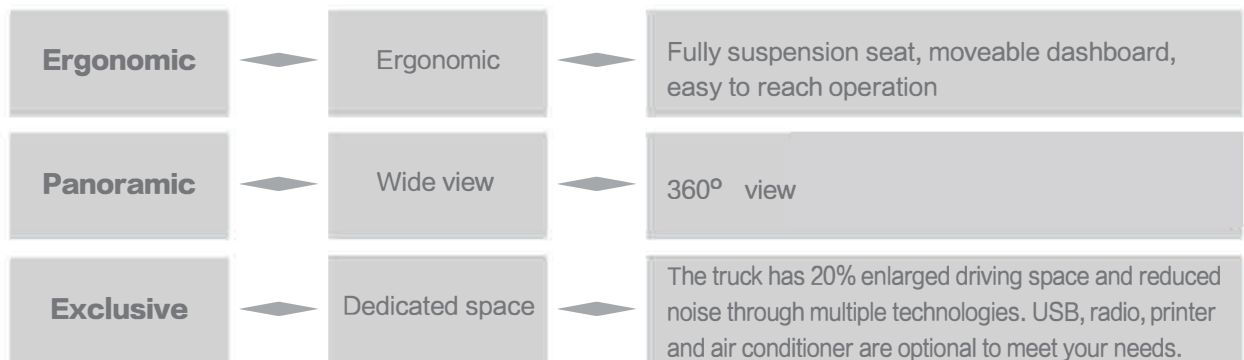



▪ **Moveable dashboard**

Most reasonable relative position is set between dashboard and seat SIP point through optimized ergonomic and multiple test. Dashboard and seat can be moved together to meet different driving needs.

▪ **Weighting system**

Weight can be measured accurately through checking hydraulic pressure.

▪ **Reversing sensors**

Seven proximity sensors are fitted to alert the operator of pedestrians and obstruction.



▪ **Fully suspension seat**

Adjustable damping shock reducing design not only bears your weight but also provides steady driving experience.

▪ **Adjustable steering wheel**

Steering wheel can be adjusted according to operator habit and easy and flexible steering largely reduces your work.

▪ **Pedal optimized layout**

Optimized pedal reduces fatigue during long time working.



▪ **Temperature control system through multiple channel**

Fully sealed cab controls temperature in the cab and multiple channels cross ventilation keep the temperature in the cab stable in winter.

▪ **Hydraulic servo controls**

Accurate, safe and effective control can be achieved through small operation force.

12-16 t

## **D** Safe and highly efficient

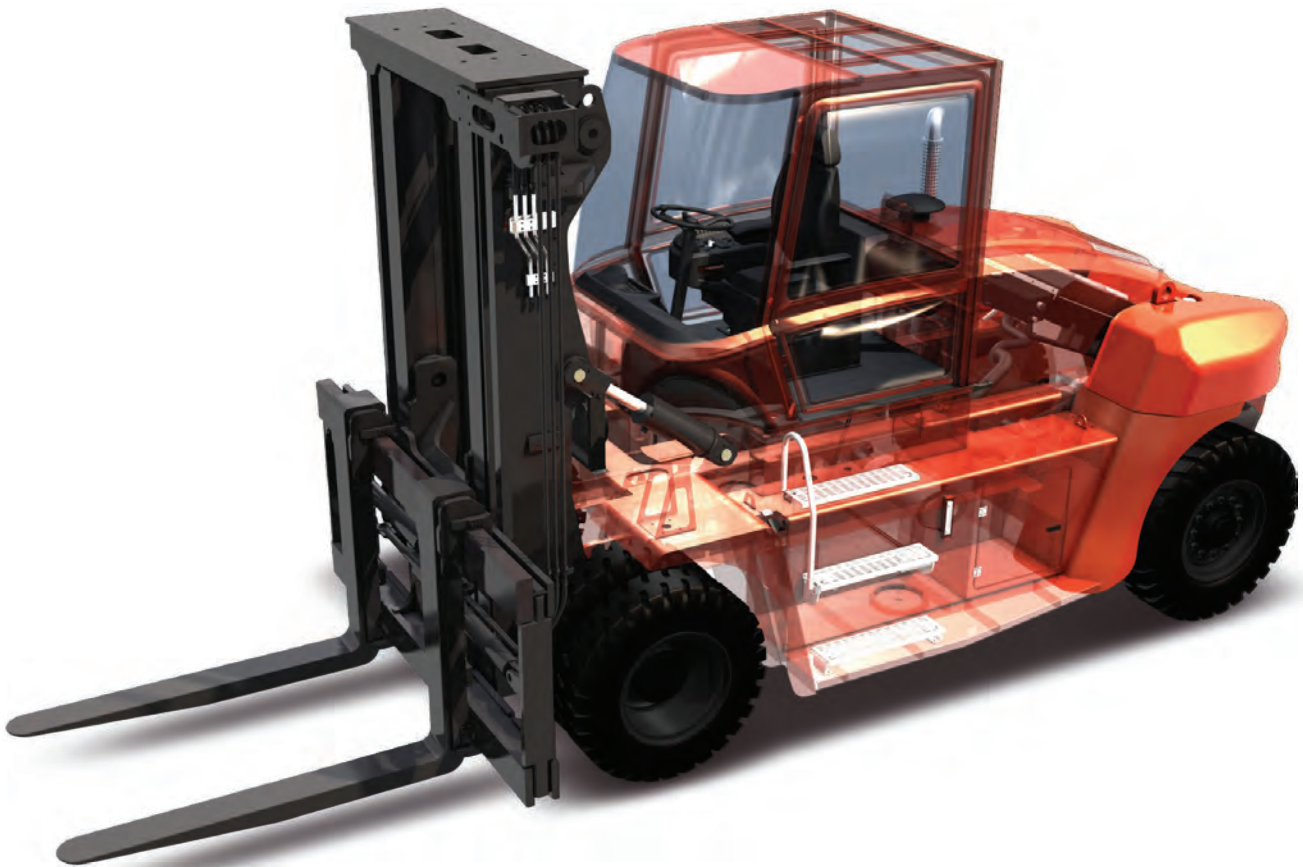

### **D.1** Improved stability

- ▶ **Smaller front overhang**  
More compact mast structure.
- ▶ **Centre of gravity is optimised**  
Repositioned drive train.  
Repositioned cooling system.  
No air channel in counter weight.



---

## D.2 OPS - Operator presence system

- ▶ Drive Lock - The forklift's drive is disabled when the operator leaves the seat.
  
- ▶ Lift Lock and Tilt Lock - The forklift's lift and tilt functions are disabled when the operator leaves the seat.



## D.3 Meritor and Kessler drive axles



### ► Unsurpassed durability

Specially designed structure and brake principle provides anti-dust and anti-water function and saves you maintenance costs.

### ► Safe and reliable brake

Multi wet disc brakes provide efficient braking while providing a maintenance free long life.

## D.4 Ergonomic operator environment



### ► Highly efficient, comfortable operation

Hydraulic servo controls provide a responsive smooth and powerful response.

Integrated dashboard layout is designed to provide convenience to the operator.

Operator fatigue is minimised with the cabin's ergonomic layout, air suspension operators seat and unsurpassed visibility.

► **Highly efficient performance**

Faster working speed.

Better gradeability.

High power output provides acceleration and gradeability.

Mast lifting and lowering speed is 5% increased.



# E Technical parameters

Technical parameters						
01	Model	Unit	CPCD120-C1Z-09IIIG	CPCD135-C1Z-06IIIG	CPCD150-C1Z-06IIIG	CPCD160-C1Z-06IIIG
02	Rated load	t	12	13.5	15	16
03	The mass	kg	17800	17800	18400	18800
04	Maximum lifting speed (loaded/unloaded)	mm/s	360/400	360/400	350/400	350/400
05	Maximum speed (loaded/unloaded)	km/h	25/27	25/27	26/28	26/28
06	Gradeability (loaded/unloaded)	%	36.4/40	36.4/40	36.4/40	36.4/40
07	Noise in the cab	dB(A)	≤73.8	≤73.8	≤73.8	≤73.8

Size parameters						
01	Model	Unit	CPCD120-C1Z-09IIIG	CPCD135-C1Z-06IIIG	CPCD150-C1Z-06IIIG	CPCD160-C1Z-06IIIG
02	Overall length		6705	6255	6265	6265
03	Overall width	mm	2560	2560	2560	2560
04	Overall height	mm	3365	3365	3380	3380
05	Load center	mm	900	600	600	600
06	Wheelbase	mm	3250	3250	3250	3250
07	Front overhang	mm	785	785	795	795
08	Rear overhang	mm	850	850	850	850
09	Minimum clearance	mm	260	260	250	250
10	Seat height	mm	1970	1970	1985	1985
11	Turning radius (inside)	mm	220	220	220	220
12	Turning radius(outside)	mm	4450	4450	4500	4500
13	Front track	mm	1888	1888	1888	1888
14	Rear track	mm	2120	2120	2120	2120
15	Mast height (retracted/extended)	mm	3365/4865	3365/4865	3380/4880	3380/4880
16	Mast lifting height	mm	3000	3000	3000	3000
17	Mast tilting angle (forward/backward)	deg	6/12	6/12	6/12	6/12
18	Fork dimension (length*width*thickness)	mm	1820 × 200 × 85	1370 × 200 × 85	1370 × 200 × 85	1370 × 200 × 85
19	Fork adjusting range	mm	500-2370	500-2370	500-2370	500-2370

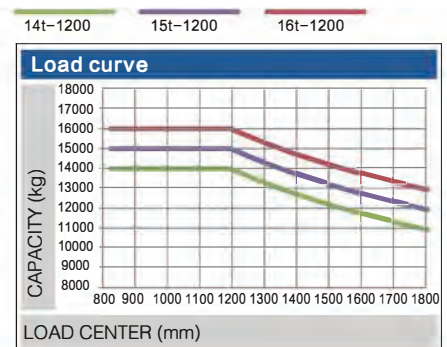
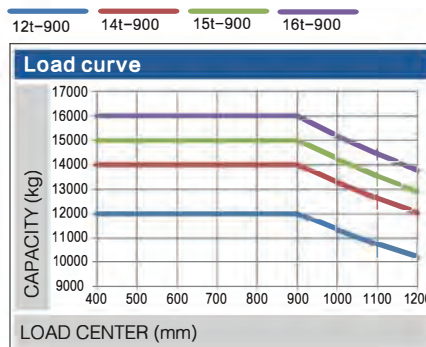
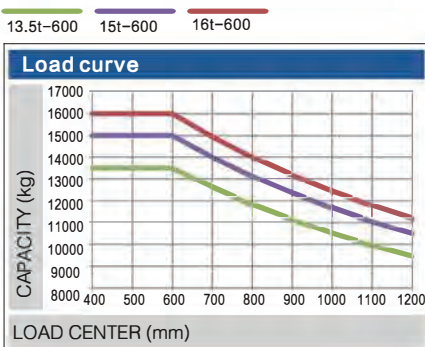

CPCD140-C1Z-09IIIIG	CPCD150-C1Z-09IIIIG	CPCD160-C1Z-09IIIIG	CPCD140-C1Z-12IIIIG	CPCD150-C1Z-12IIIIG	CPCD160-C1Z-12IIIIG
14	15	16	14	15	16
20500	21000	21500	21400	22200	23000
370/415	370/415	370/415	370/415	370/415	370/415
26.2/27.3	26.2/27.3	26.2/27.3	26.5/27.6	26.2/27.3	25.3/27
36.4/40	36.4/40	36.4/40	36.4/40	36.4/40	36.4/40
≤73.8	≤73.8	≤73.8	≤73.8	≤73.8	≤73.8

CPCD140-C1Z-09IIIIG	CPCD150-C1Z-09IIIIG	CPCD160-C1Z-09IIIIG	CPCD140-C1Z-12IIIIG	CPCD150-C1Z-12IIIIG	CPCD160-C1Z-12IIIIG
7105	7105	7105	7975	7975	7975
2560	2560	2560	2560	2560	2560
3340	3340	3340	3340	3340	3340
900	900	900	1200	1200	1200
3500	3500	3500	3750	3750	3750
935	935	935	935	935	935
850	850	850	850	850	850
275	275	275	275	275	275
1985	1985	1985	1985	1985	1985
220	220	220	220	220	220
4750	4750	4750	5100	5100	5100
1895	1895	1895	1895	1895	1895
2120	2120	2120	2120	2120	2120
3340/4840	3340/4840	3340/4840	3340/4840	3340/4840	3340/4840
3000	3000	3000	3000	3000	3000
6/12	6/12	6/12	6/12	6/12	6/12
1820 × 200 × 95	1820 × 200 × 95	1820 × 200 × 95	2440x200x100	2440x200x100	2440x200x100
610-2150	610-2150	610-2150	610-2150	610-2150	610-2150

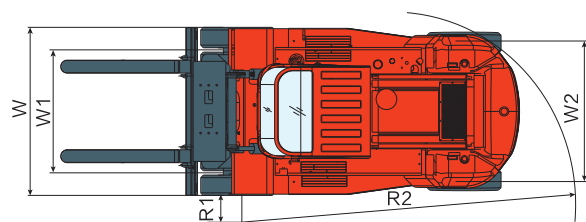
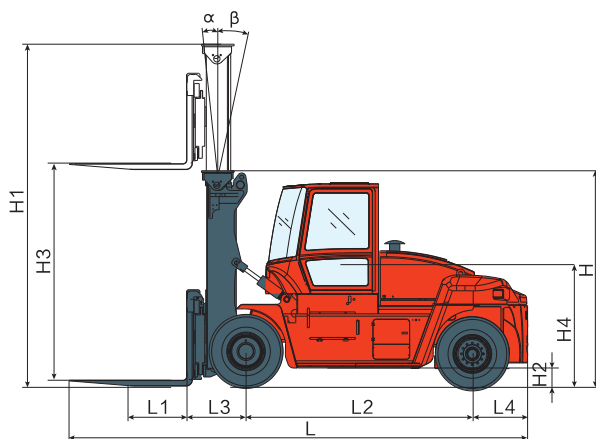

12-16 t

# G Optional mast and carriages

## Mast



- **Two stage duplex mast**  
Suitable for most applications where overall height is less important.



- **Two-stage full free mast**  
Suitable for applications where the overall height of the mast must be maintained during elevation of the forks and carriage.



- **Three-stage full free mast**  
For applications that demand the lowest mast collapsed height with the carriage and forks being the highest point once the free lift is exhausted.

## MLA Fleet Control

- Pre shift checklist management and customisation
- Prevents unauthorised equipment use
- Operator identification and license management
- Impact reporting with threshold customisation
- Forklift utilisation management
- Communications direct to the operator via the system
- Schedule service interval reminders
- Identification of maintenance issues at pre start
- GPS equipment location
- Real time remote access to authorised user
- Exception alerts and reporting to nominated email recipients



## Attachments



- **Fork positioner**

It is easy and quick with two forks adjusting powered by hydraulics.



- **Side shifting fork positioner**

It has both space adjusting and side shifting functions to improving working efficiency.



- **Side shifter**

Side shifting and space adjusting function are separated from each other to achieve a quick response.



- **Fork extension**

It effectively extends fork and it is suitable for large size handling.



- **Coil probe**

Designed handle coil steel - horizontal bore.



- **Crane jib**

It is safe and highly efficient to lift goods.



- **Slings**

It is suitable for goods in a bundle such as rebar, steel tube and so on.

# HELI *“Lifting the Future”*

The MLA team includes highly skilled, hands-on technicians. Ongoing training ensures a quality service experience from people who are dedicated and committed to excellence. Dealer service technicians are available nationally to make sure your investment (and your business) stays up and running.

MLA operates seven wholly owned branches in five states and an extensive dealer network covering Tasmania, the NT and regional areas offering an extensive range of products and services. New and used equipment is available at MLA branches for your inspection. Please call to arrange for MLA to assist you.

## HEAD OFFICE

10 Walker Place  
 (Locked Bag 3000)  
 Wetherill Park NSW 2164  
 Telephone (02) 9765 2000  
 Fax (02) 9725 1972  
 Email: [sales@mlaholdings.com.au](mailto:sales@mlaholdings.com.au)  
 Web: [www.mlaholdings.com.au](http://www.mlaholdings.com.au)

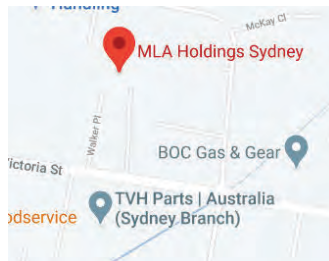

## NEW SOUTH WALES BRANCH

10 Walker Place  
 (Locked Bag 3000)  
 Wetherill Park NSW 2164  
 Telephone (02) 9765 2000  
 Fax (02) 9725 1972  
 Email: [sales@mlaholdings.com.au](mailto:sales@mlaholdings.com.au)  
 Web: [www.mlaholdings.com.au](http://www.mlaholdings.com.au)

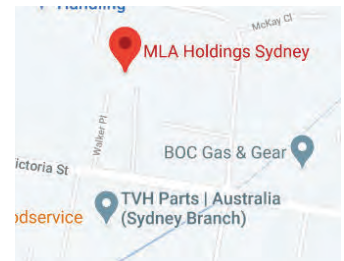

## VICTORIA BRANCH

43 Wright Road  
 Keilor Park VIC 3042  
 Telephone: (03) 9353 2100  
 Email: [vic@mlaholdings.com.au](mailto:vic@mlaholdings.com.au)

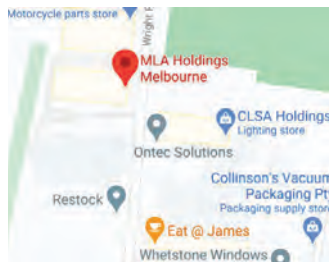

## QUEENSLAND BRANCH

247 Monier Road  
 Darra QLD 4076  
 Telephone: (07) 3376 7488  
 Email: [qld@mlaholdings.com.au](mailto:qld@mlaholdings.com.au)

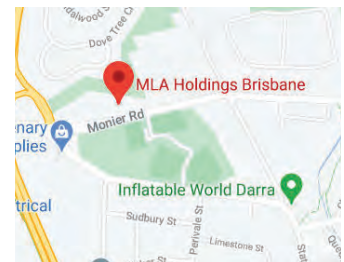

## SOUTH AUSTRALIA BRANCH

585 South Road  
 Regency Park SA 5010  
 Telephone: (08) 8244 2488  
 Email: [sa@mlaholdings.com.au](mailto:sa@mlaholdings.com.au)

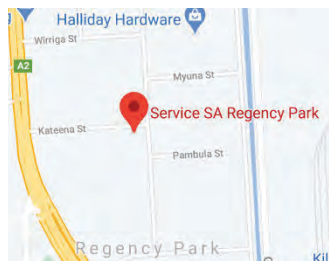

## WESTERN AUSTRALIA BRANCH

229 Barrington Street  
 Bibra Lake WA 6163  
 Telephone: (08) 9434 2999  
 Email: [wa@mlaholdings.com.au](mailto:wa@mlaholdings.com.au)

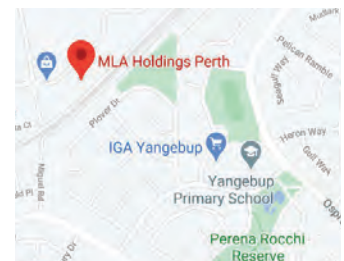

## GOLD COAST BRANCH

8 Trade Ct  
 Molendinar QLD 4124  
 Telephone: (07) 5571 7600  
 Web: [www.classicmla.com.au](http://www.classicmla.com.au)  
 Email: [info@classicforklifts.com.au](mailto:info@classicforklifts.com.au)

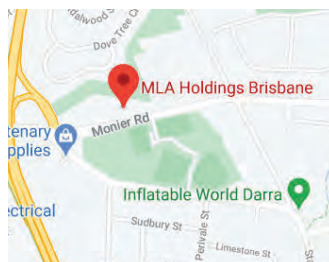

## NEWCASTLE BRANCH

21 Craftsman Close  
 Beresfield NSW 2322  
 Telephone: (02) 4967 4622  
 Web: [www.huntermla.com.au](http://www.huntermla.com.au)  
 Email: [sales@hunterlift.com.au](mailto:sales@hunterlift.com.au)

